

# GE SB 48-IN NEON FLEX LED NUTCRACKER

## ASSEMBLY INSTRUCTIONS

82304



### Assembly Parts

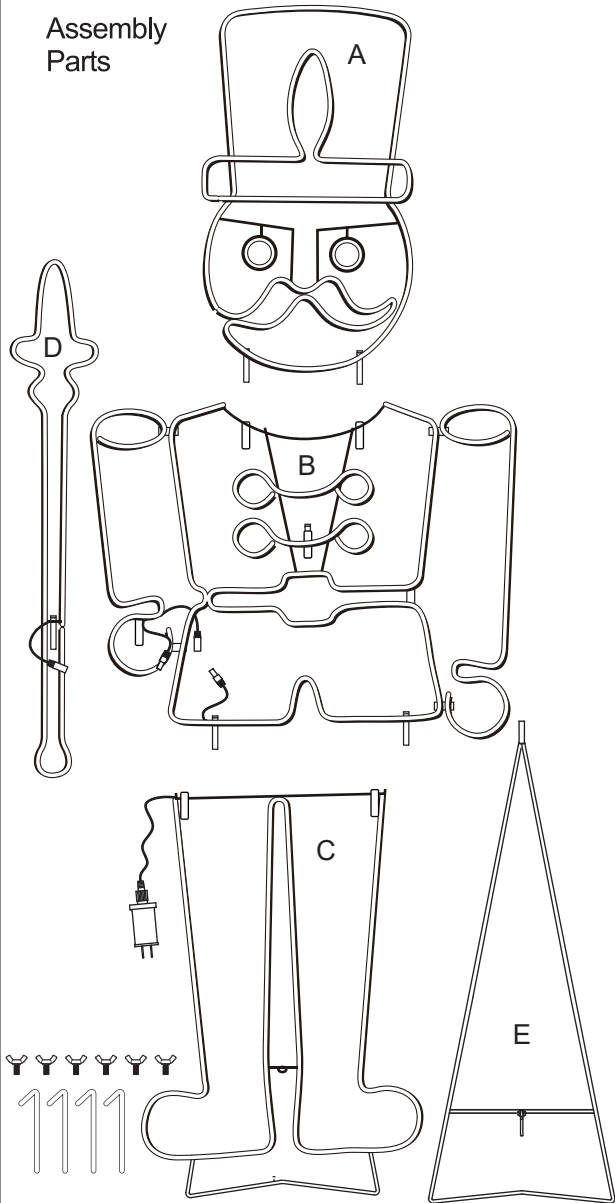

**Step 1:** Insert part B into C according to the figure, and tighten the screw to lock. Connect the male and female power cables.

**Step 2:** Insert B into part E according to the figure, and tighten the screw to lock. Insert the hook into the hole.

**Step 3:** Insert part A into B according to the figure, and tighten the screw to lock. Connect the male and female power cables.

**Step 4:** Insert part D into B according to the figure, and tighten the screw to lock. Connect the male and female power cables. Fix the four stakes at E and C according to the figure.

Step 1

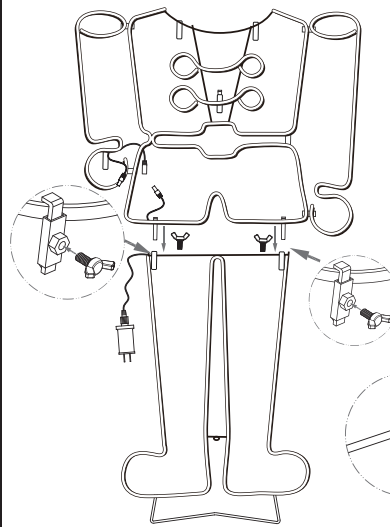

Step 2

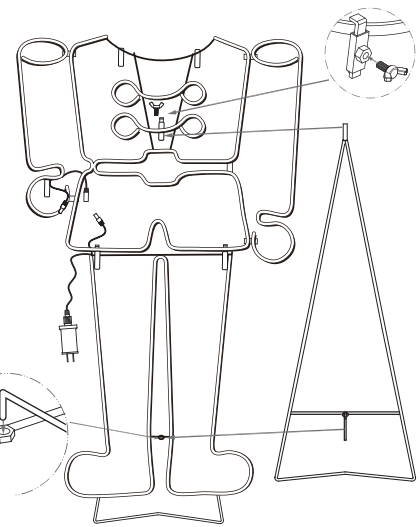

Step 3

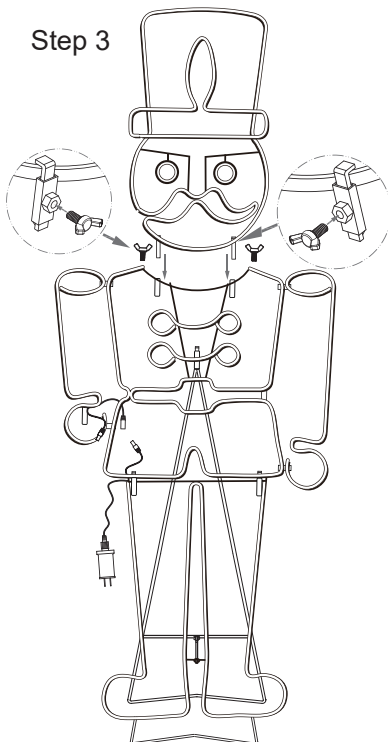

Step 4

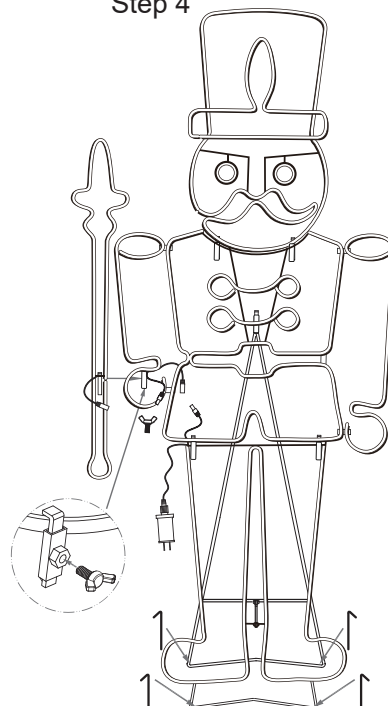

Assembly Complete

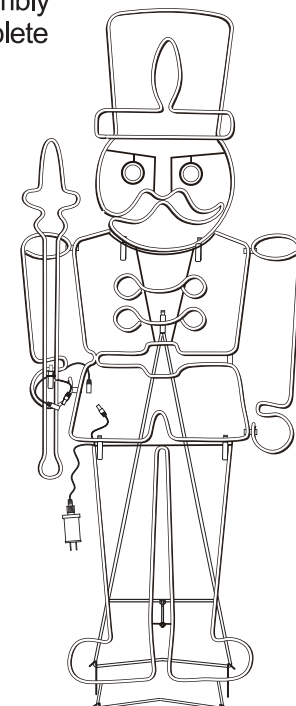

Made In China

# GE SB 48" SOLDADO DE CASCANUECES

## INSTRUCCIONES DE ENSAMBLAJE

82304



### Piezas de ensamblaje

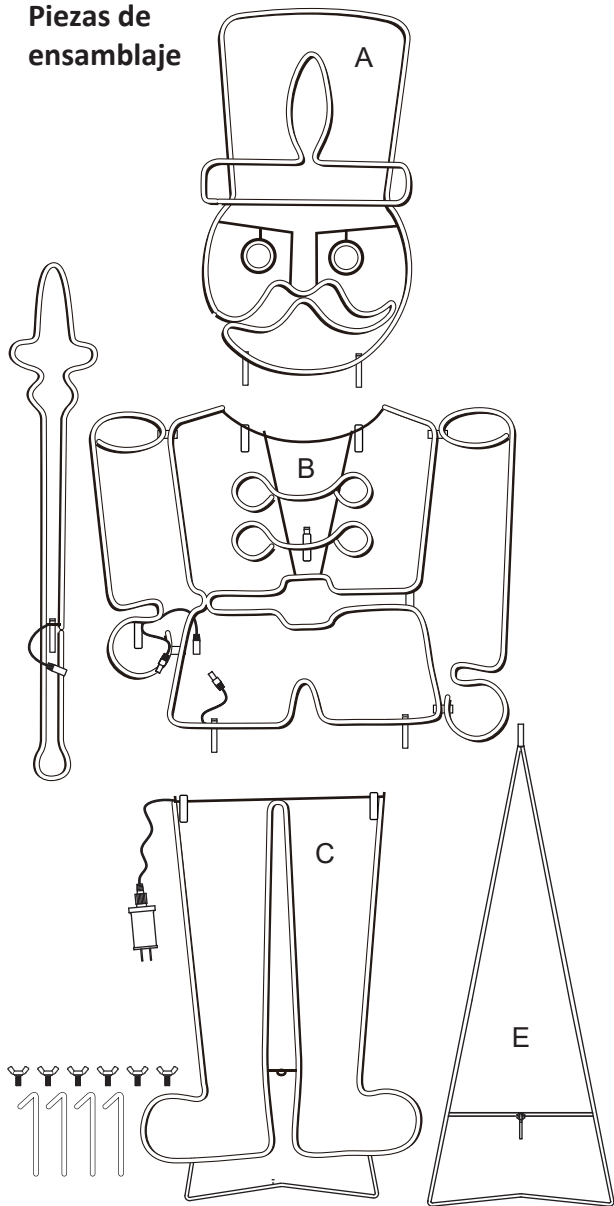

**Paso 1:** Insertar la parte B en C de acuerdo con la figura, y apretar el Tornillo a cerrar. Conecte los cables de alimentación macho y hembra.

**Paso 2:** Insertar B en la parte E de acuerdo a la figura, y apretar el Tornillo a cerrar. Inserte el gancho en el agujero.

**Paso 3:** Insertar la parte A en B de acuerdo con la figura, y apretar el Tornillo a cerrar. Conecte los cables de alimentación macho y hembra.

**Paso 4:** Insertar la parte D en B de acuerdo con la figura, y apretar el Tornillo a cerrar. Conecte los cables de alimentación macho y hembra. Fije las cuatro estacas en E y C según la figura.

Paso 1

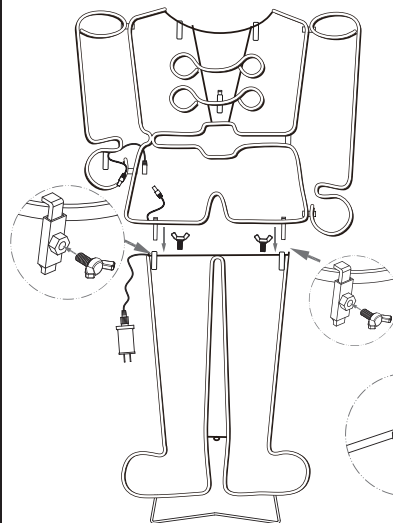

Paso 2

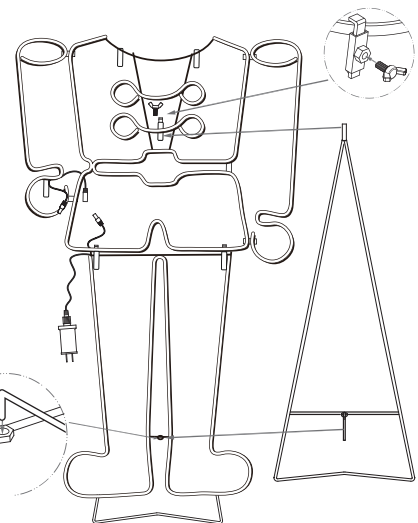

Paso 3

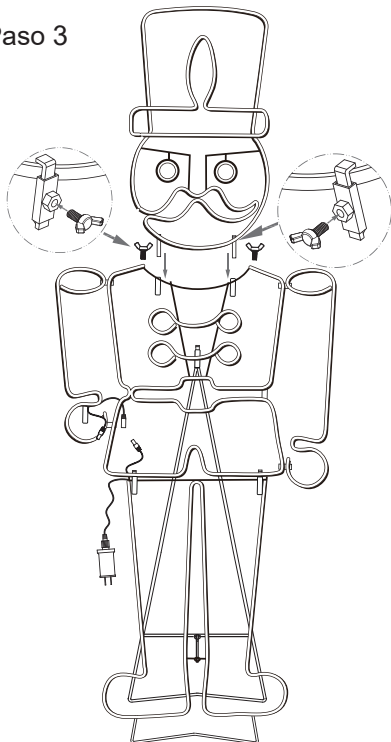

Paso 4

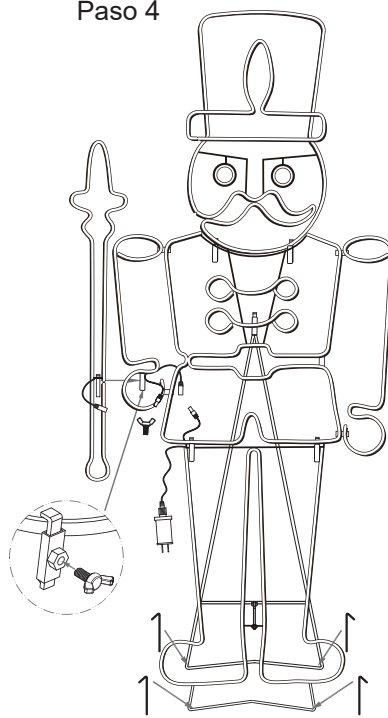

Ensamblaje completado

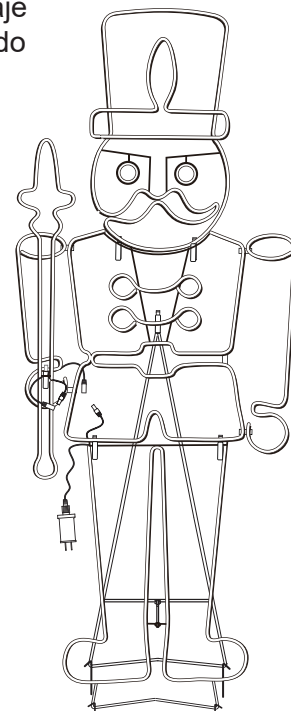

Hecho en China