

Instrucciones de ensamblaje para el JUEGO DE 100 LUCES DE C9

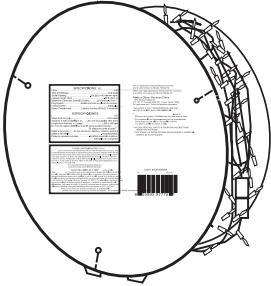

NHL Modelo No. 97732LO / 97735LO

Piezas para el ensamblaje



① Ensamblaje

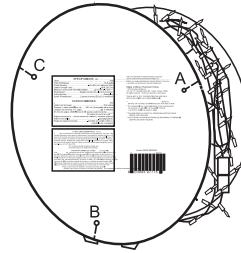

A . B . C :

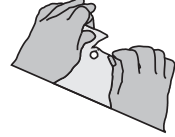

Rompa por las líneas de puntos a ambos lados como se muestra.

② Ensamblaje

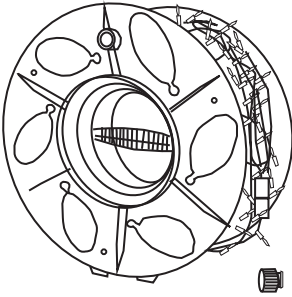

③ Ensamblaje

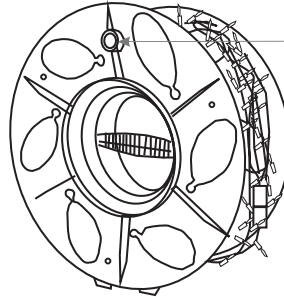

Inserte la perilla en el orificio como se muestra.

④ Ensamblaje completo

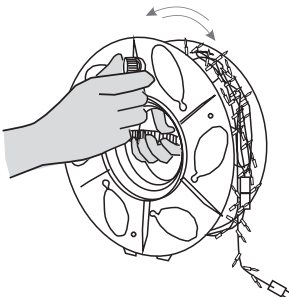

1. Quite con cuidado el enchufe con espigas de la abertura al lado del carrete.
2. Use la perilla para desenrollar los dos juegos de cuerdas de luces con una mano sosteniendo la manija del centro.
3. Retire el conector de extremo de la abertura al lado del carrete.
4. Al final de la temporada, coloque el conector de extremo entre el espacio de una abertura lateral del carrete y enrolle líneas de luces en el carrete como se muestra en el paso 2.

LED 100L C9 Assembly Instructions



NHL Model No. 97732LO / 97735LO

Assembly Parts

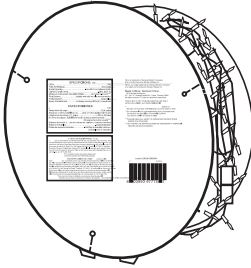

① Assembly

A . B . C :

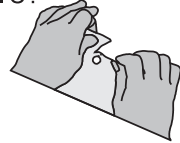
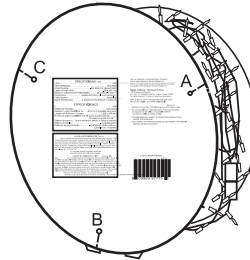

Tear off dotted lines on both side as shown

② Assembly

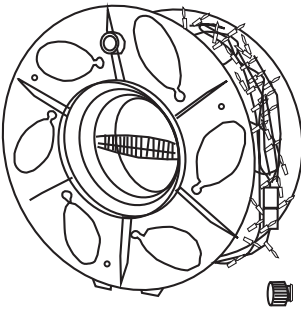

③ Assembly

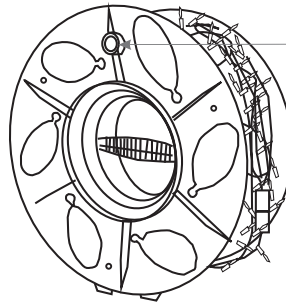

Insert knob into hole as shown.

④ Assembly

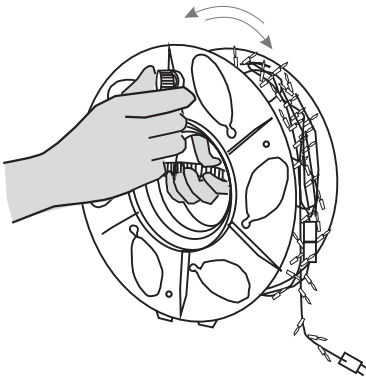

1. Carefully remove the bladed plug from the opening on the side of the spool.
2. With one hand gripping the center handle, use the knob to unreel the two light string sets.
3. Remove the end connector from the opening on the side of the spool.
4. At season's end, place the end connector through a slotted side opening in the spool and reel both light string onto the spool as noted in step 2.