

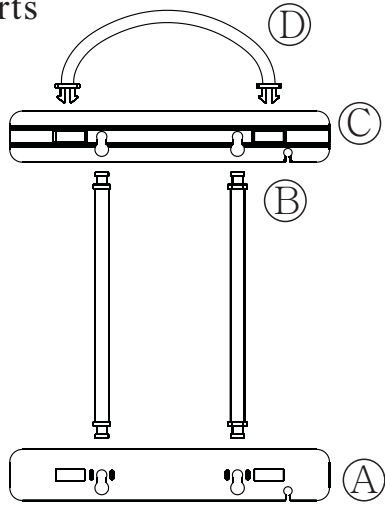

Light Storage Rack Assembly Instructions

ITEM No. 91055LO
91056LO

Assembly Parts



3 PCS

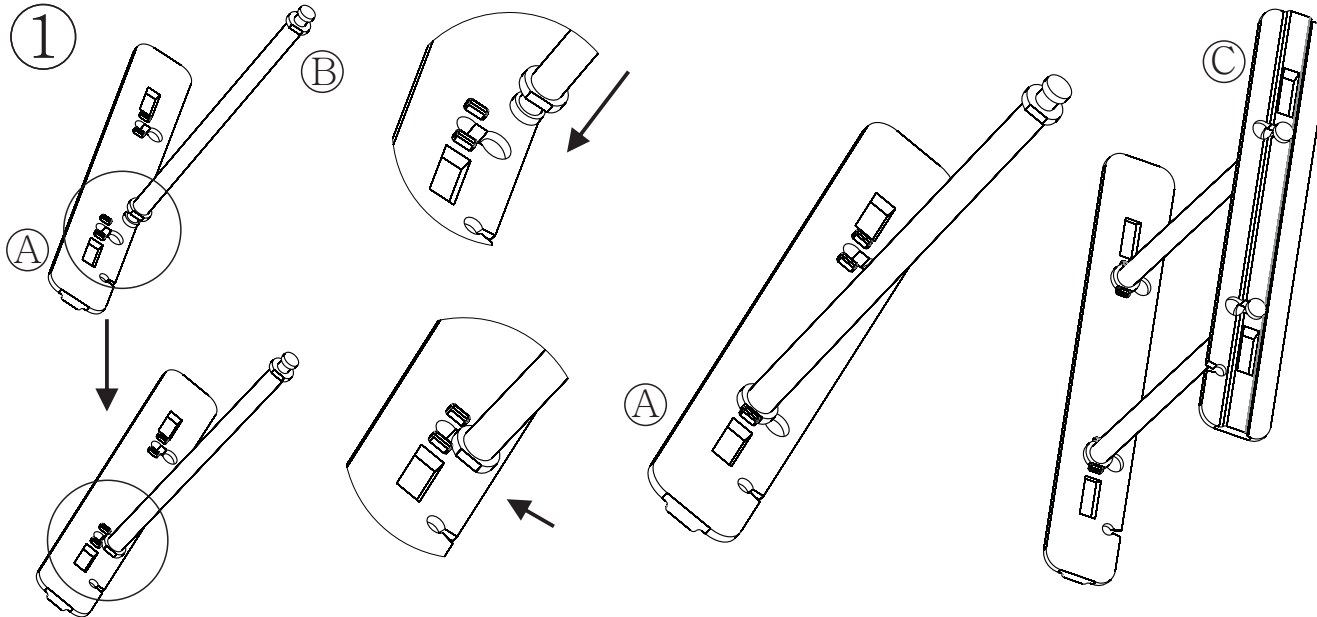

1. Insert post (B) into base (A) and lock into place. Repeat step for second post.

2. Insert both posts into top (C) and lock into place.

2

1. Insert handle (D) into top (C) as shown and lock into place.

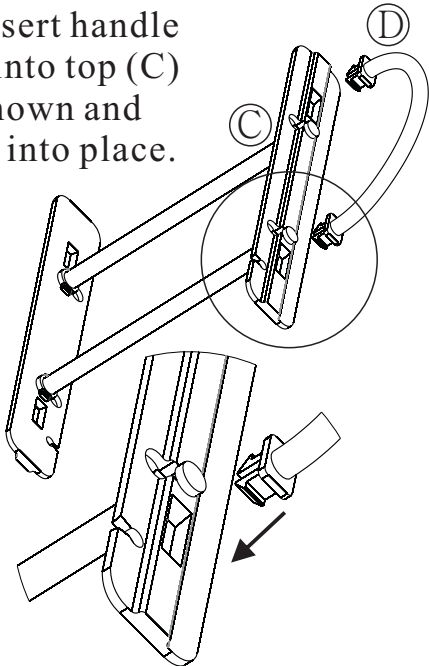

3

Assembly Complete

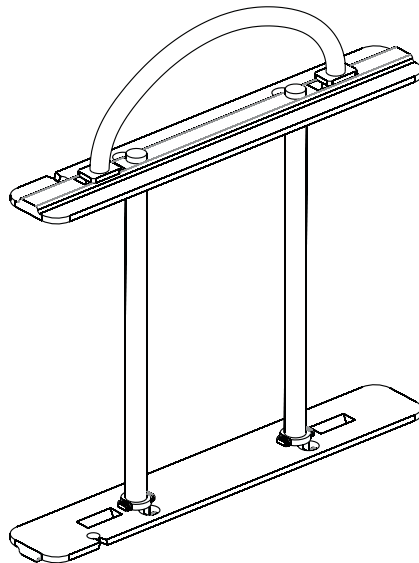

4

1. Wrap light string set around both posts as shown.

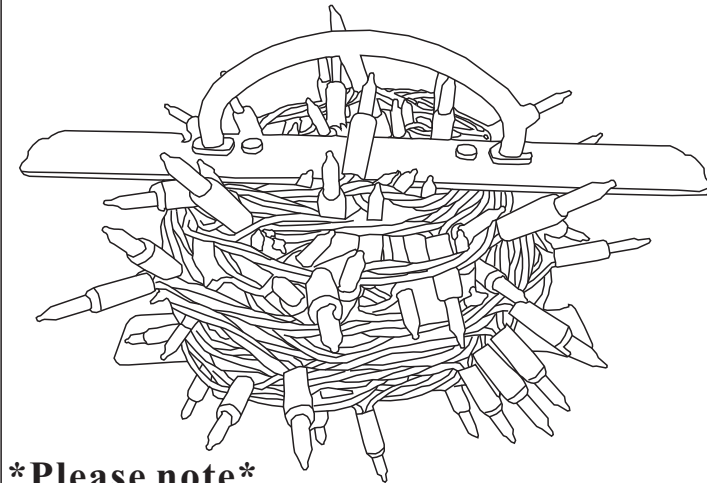
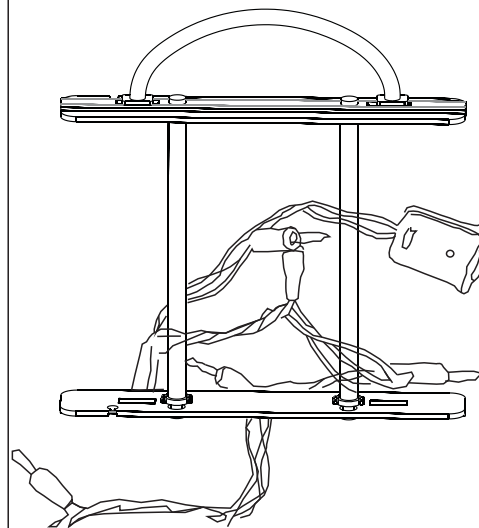

Please note

This storage box contains XX light storage racks. If you choose to use them, once the light strings are wrapped on them, they will no longer fit inside the storage box.

Printed in China 2018



Instrucciones para ensamblar la parrilla para el almacenaje de luces

ARTÍCULO No. 91055LO
91056LO

Piezas para el ensamblaje

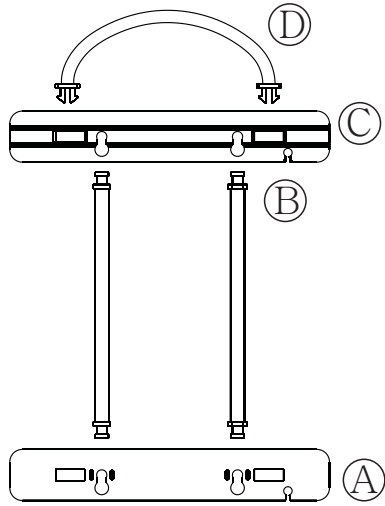

3 pzas

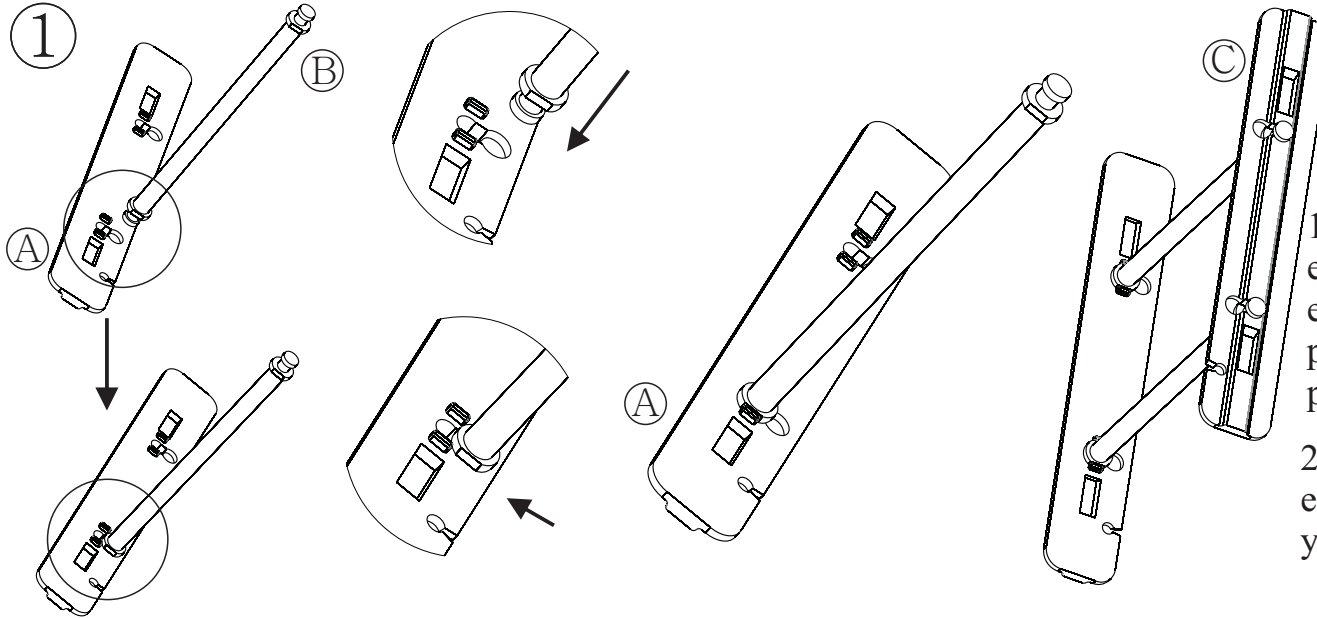

1. Inserte el poste (B) en la base (A) y trábelo en su lugar. Repita este paso para el segundo poste.

2. Inserte ambos postes en la parte superior (C) y trábelos en su lugar.

2

1. Inserte la manija (D) en la parte superior (C) como se muestra y trábela en su lugar.

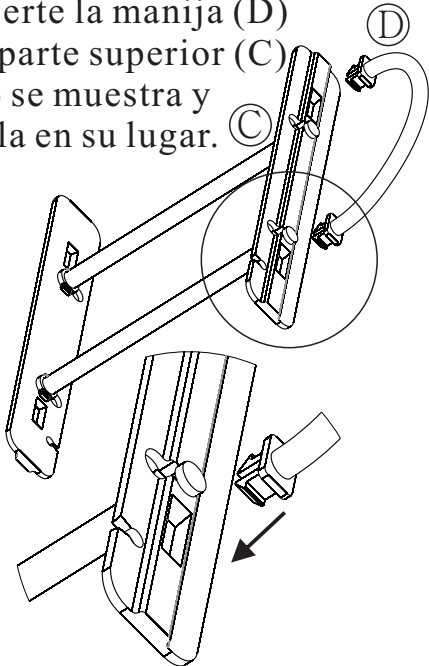

3

Ya está ensamblada

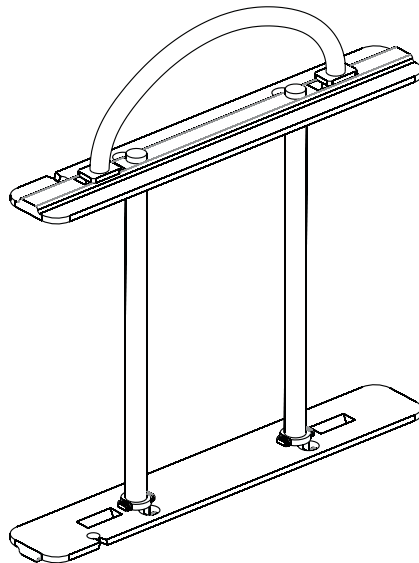

4

1. Enrolle el juego de línea de luces alrededor de ambos postes como se muestra.

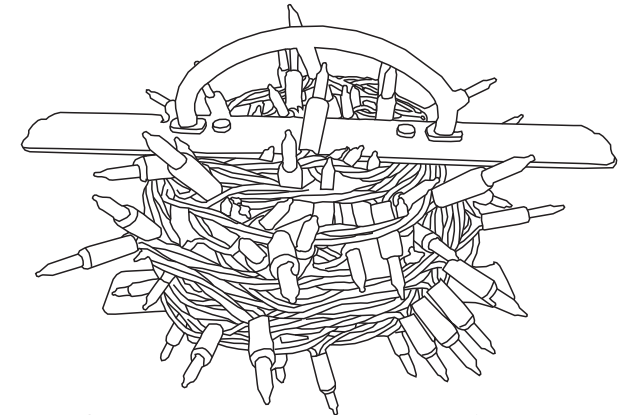
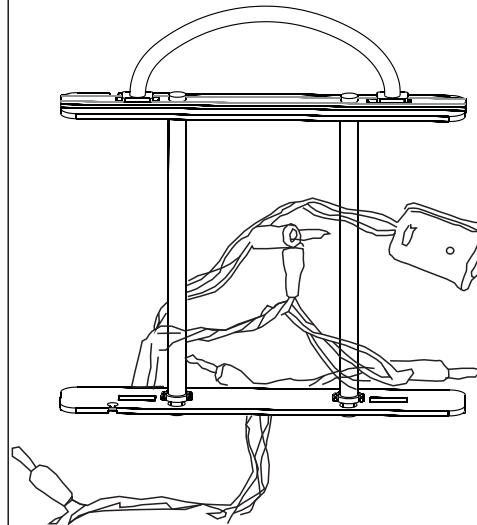

Por favor, tenga presente
Esta caja para almacenaje contiene XX parrillas para guardar luces.
Si usted decide usarlas, una vez que las líneas de luces se enrollan en estas, ya no cabrán más en el interior de la caja para almacenaje.

Impreso en China en 2018